



USL  
BridgeCare

Approved Supplier & Contractor

**PITCHMASTIC** PmB  
International

[www.usluk.com](http://www.usluk.com)

# Transflex Bridge Joints

Reinforced Elastomeric Joint System

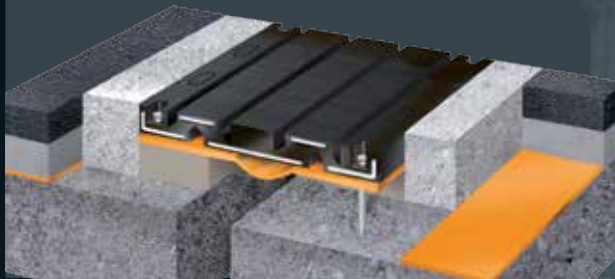

## Market Leaders in Expansion Joint Technology

USL BridgeCare provides a complete service to the civil engineering industry for bridge deck protection which includes the supply and installation of expansion joints and spray applied bridge deck waterproofing membranes.

The bridge expansion joint range of products caters for movements from 20mm through to 330mm.

The division also manufactures and applies their Britdex MDP waterproofing system which is a rapid curing, spray applied methyl methacrylate membrane. All of USL's products have a proven track record and comply with the latest Highways Agency requirements.

Through their technical department USL BridgeCare are able to offer a complete package of services to clients and will review a particular application from initial design to final installation to ensure the selection of the most appropriate and cost effective solution.

Figure 1

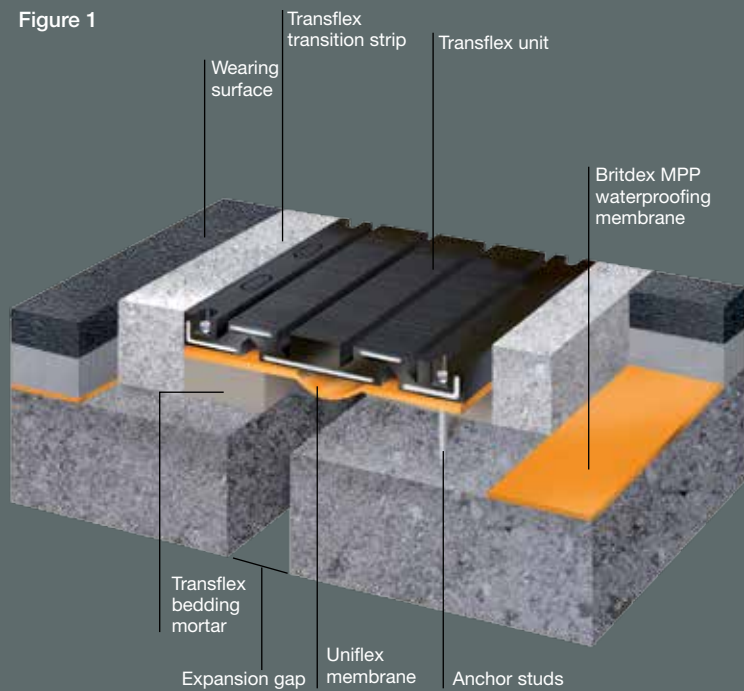

## The product in brief

The Transflex system is registered with the UK Highways Agency, the Scottish Executive and the Welsh Assembly for use on highway bridge decks on all classes of roads and motorways. (BD 33/94: Joint Type 5 refers). The Transflex system is included in the UK Highways Agency list of approved products SA1. Britflex Resin Mortar is also included in SA1 as an approved material for transition strips to all types of expansion joint.

USL Transflex bridge joints comprise of steel angles and a steel bridging plate system encased in a flexible elastomer. They are supplied in module lengths designed to be bolted to the structural concrete on either side of the expansion gap. A range of models are available to accommodate movement up to 330mm, providing a substantially waterproof joint and a smooth running surface.

- Movement accommodation up to 330mm
- Corrosive resistant elastomer casing
- Accommodates skew movement
- Factory vulcanised kerb and skew kerb units to special order
- Membrane system included for maximum waterproofing

### Principal applications

- Highway bridge decks
- Service Ramps
- Multi-storey car parks

## Design features

Transflex bridge joint 150, 200, 250 and 300

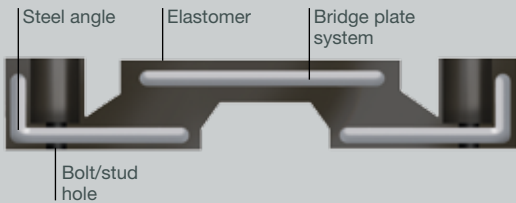

Transflex bridge joint 400, 650, 900 and 1300

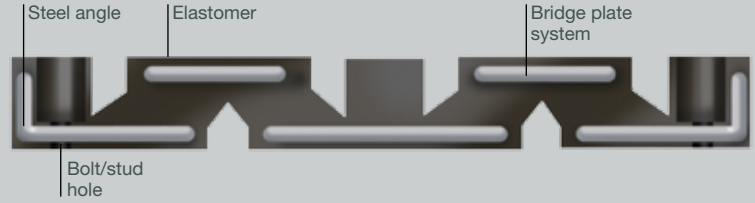

Typical cross section through carriageway joint

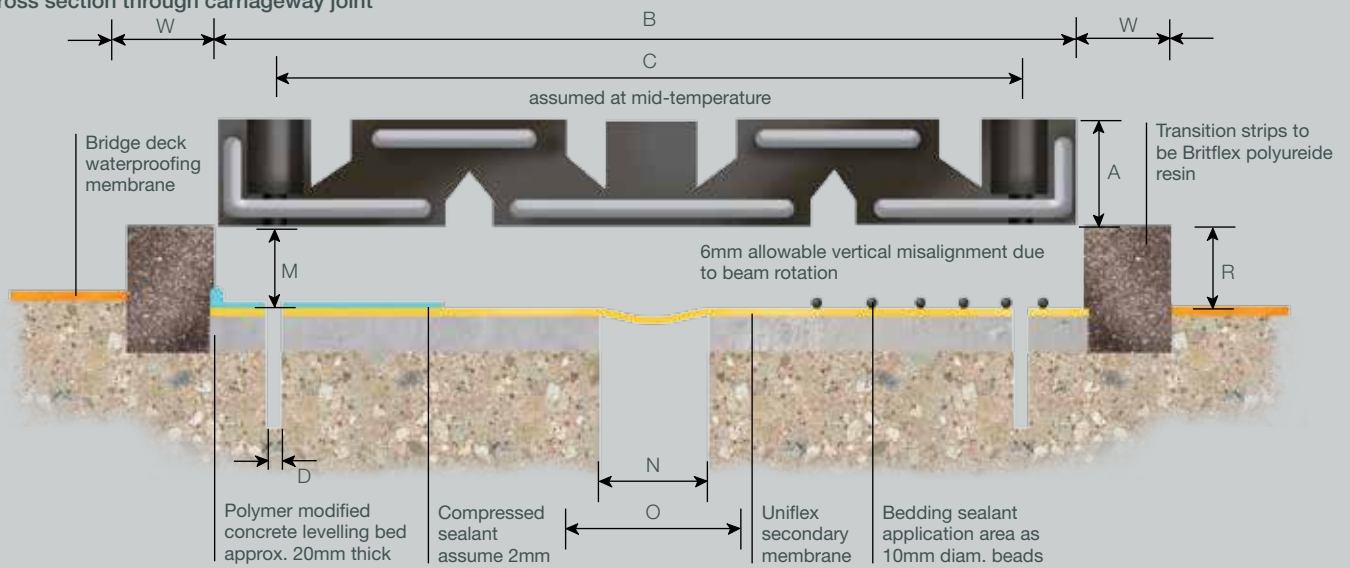

## USL Transflex bridge joint models

Movement accommodation	Module length	Module width B	Module depth A	Stud diameter D	Module weight	Max stud height above shelf M	Bolt torque	Max joint width at mid-deck temp N
38mm	1750mm	240mm	35mm	12mm	30kg	32mm	38Nm	35mm
50mm	1830mm	274mm	40mm	12mm	48kg	32mm	38Nm	51mm
65mm	1830mm	356mm	46mm	16mm	68kg	40mm	95Nm	67mm
76mm	1830mm	432mm	52mm	20mm	88kg	42mm	175Nm	83mm
102mm	1830mm	590mm	54mm	20mm	150kg	42mm	175Nm	102mm
165mm	1830mm	724mm	75mm	24mm	272kg	50mm	190Nm	121mm
230mm	1830mm	890mm	93mm	24mm	375kg	60mm	275Nm	158mm
330mm	1220mm	1204mm	127mm	30mm	451kg	70mm	300Nm	216mm

Note: Add 3mm to the recess depth 'R' when using the Uniflex secondary membrane.

## Design features

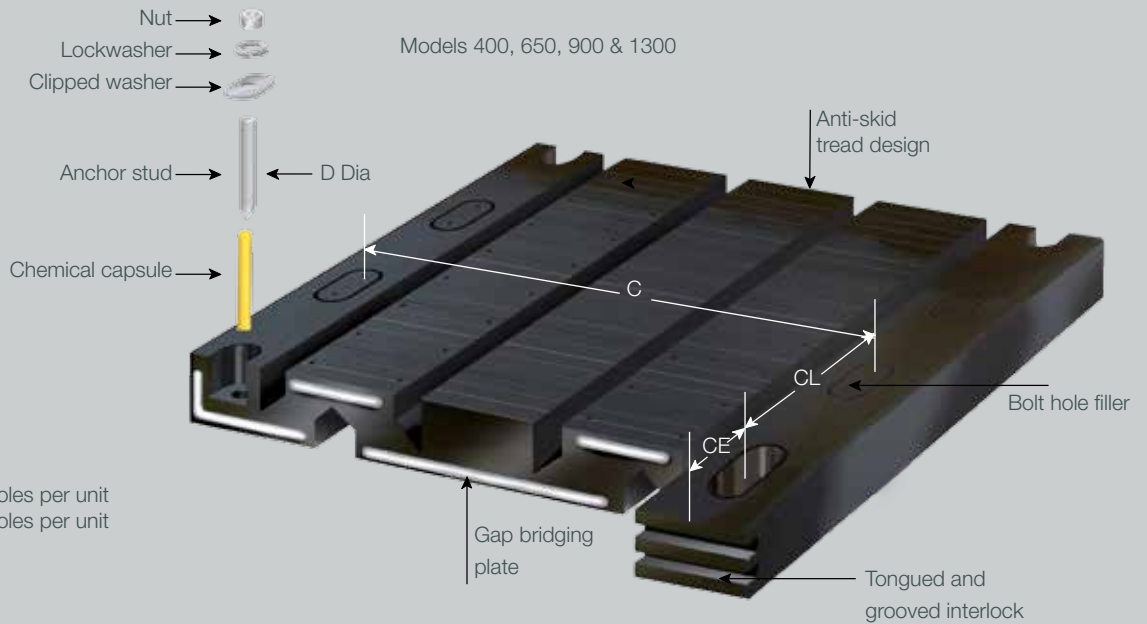

**NB:** Model 1300 has 8 bolt holes per unit  
Model 150 has 14 bolt holes per unit

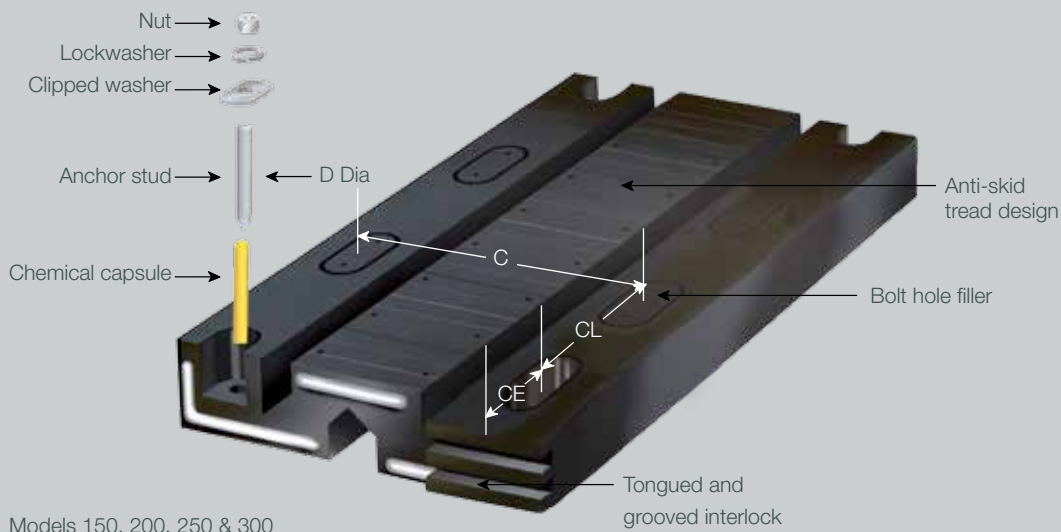

Models 150, 200, 250 & 300

Max joint width O	Recess depth R	Transition strip width W	Bolt hole centres C	Bolt hole centre along unit CL	End of unit to first bolt hole CE	Models
54mm	41mm	100mm	190mm	250mm	125mm	150 
76mm	46mm	100mm	220mm	305mm	152mm	200 
98mm	52mm	100mm	279mm	305mm	152mm	250 
121mm	58mm	100mm	342mm	305mm	152mm	300 
152mm	62mm	100mm	498mm	305mm	152mm	400 
203mm	81mm	125mm	618mm	305mm	152mm	650 
273mm	99mm	150mm	787mm	305mm	152mm	900 
381mm	133mm	175mm	1080mm	305mm	152mm	1300 

## Technical specifications

Property	Standard	Value
Hardness	ASTM D2240	62°± 5° Shore 'A'
Tensile strength (min)	ASTM D412	130kg/cm <sup>2</sup> min
Elongation at break (min)	ASTM D412	400% min
Low temperature brittleness	ASTM D746	-30°C (Not brittle)
Ozone resistance (After 48hrs. At 38°C exposure to 50 PPHM in air sample under 20% strain)	ASTM D1149	No cracks
Resistance to permanent set (24hrs. At 70°C)	ASTM D395	35% max
Oil resistance	ASTM D471	+ 18%
	<b>Requirements</b>	<b>Test method</b>
Steel	Steel components manufactured to:	DIN 17-100 Type ST 37-2 ASTM Type A36

Manufactured to DIN 37-2

	150	200	250	300	400	650	900	1300
a	34mm	34mm	45mm	60mm	60mm	65mm	72mm	70mm
b	27mm	27mm	35mm	50mm	50mm	55mm	51mm	60mm
d	14mm	14mm	17mm	21mm	21mm	25mm	25mm	31mm
t	3.0mm	3.0mm	3.7mm	4.0mm	4.0mm	4.5mm	6.0mm	6.0mm

Steel clipped washers

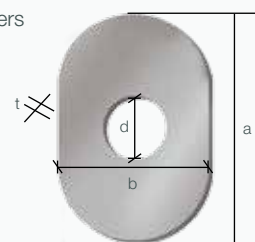

## Description

The USL Transflex bridge joint system comprises of 8 No. standard models designed to accommodate movement up to 330mm by shear deformation of the elastomer between the steel components.

Each model incorporates steel angles designed to be bolted to the structural deck and a steel bridging plate system which spans the open joint gap.

The elastomer case is highly resistant to oils, solvent spillage and the trafficked surface includes an anti-skid pattern for safety having a rubber to rubber coefficient of static friction of 0.69. Each model is specifically designed to accommodate horizontal and skew movement and will also accommodate vertical movement due to rotation of up to 6mm.

Special steel clipped washers are provided with each unit designed specifically for the Transflex joint. Stainless steel washers to the same high specification can be supplied to special order.

It is important that the correct washer is used in each case. When additional waterproofing is specified a continuous length of Uniflex membrane should be bonded to the levelling bed with adhesive over the full width of the Transflex joint unit. Drain outlets will be incorporated.

### Rebond profiles

During installation it is sometimes necessary, for practical reasons, to cut a Transflex unit on-site. In order to maintain the integrity of the joint between each module, male and female rebond profiles are available for each unit to reinstate the end configuration as required.

The profiles are available in lengths for cutting on-site together with an adhesive.

### Factory Vulcanised junctions

Special factory vulcanised junctions and kerb units are available to accommodate changes in level at kerbs and central reservations, in addition, standard units are capable of being modified on-site to accommodate some level changes.

## Technical Data

### Performance

Transflex bridge joints are designed to accept both horizontal and vertical loads due to traffic in accordance with the UK Highways Agency Technical Memorandum BD 33/94.

The graphs illustrated opposite are an indication of the horizontal load required to deflect each Transflex joint.

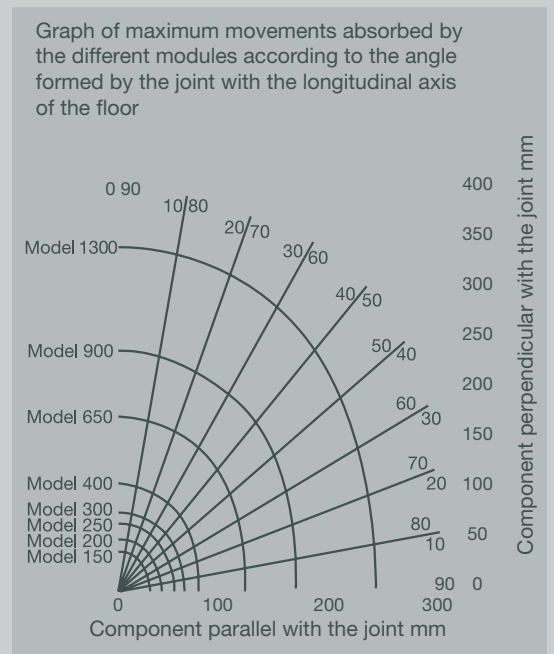
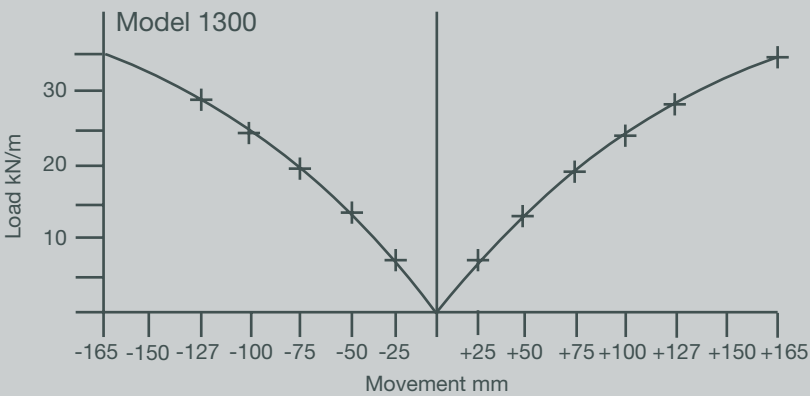
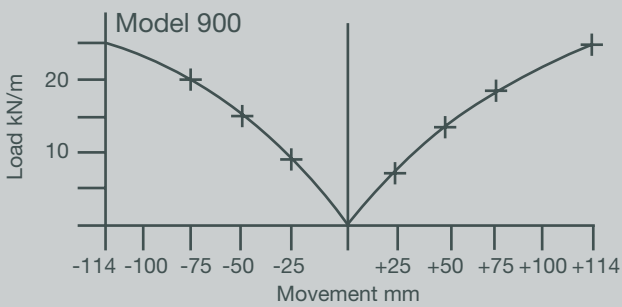
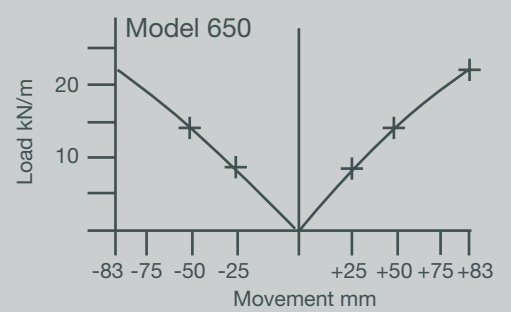
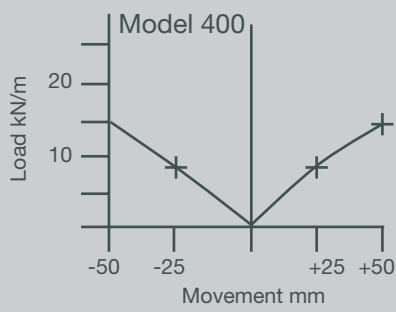
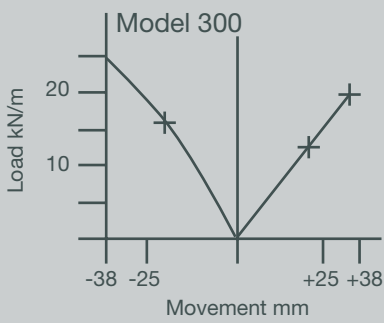
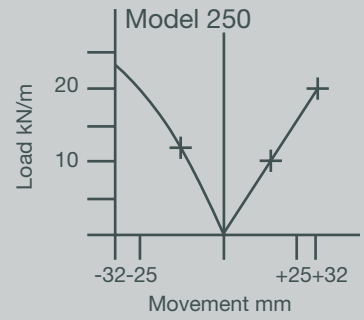
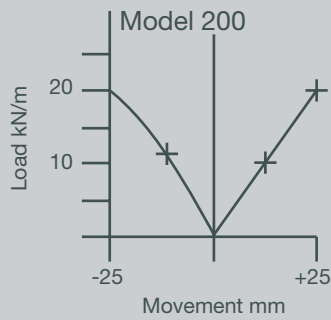
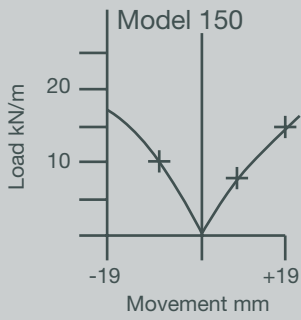

Load/movement curves for USL Transflex bridge joints

Notation:  
 - = Compression  
 + = Extension

## Kerb upstand units

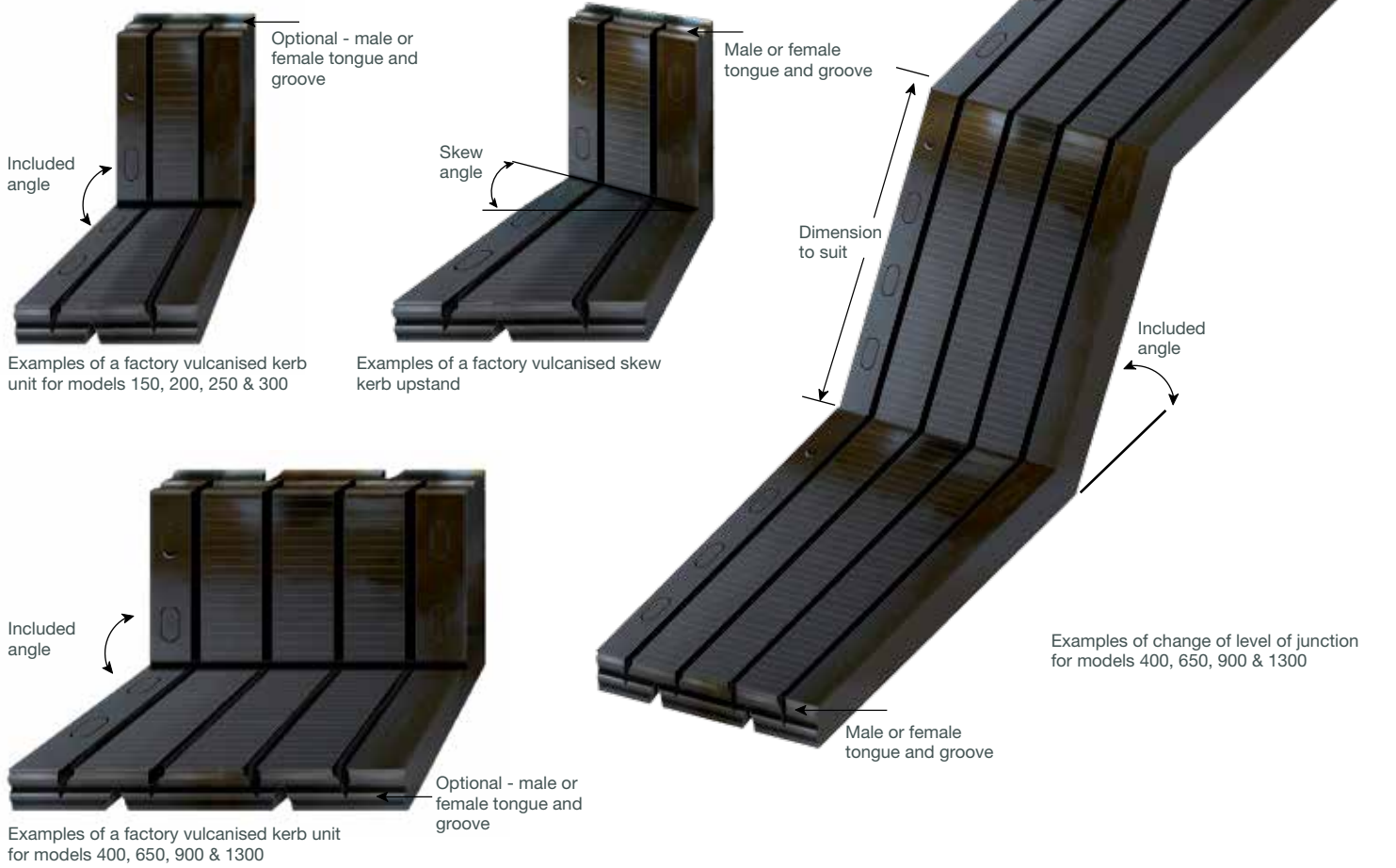

### Factory Vulcanised junctions

As part of a bridge joint installation scheme factory vulcanised junctions are available to accommodate the change in level at kerbs, footways and at the central reservation subject to special order and design detail.

The junctions available include kerb units, skew kerb units and change of level units, each factory vulcanised to maintain high quality standards and integrity of the seal.

### Kerb Units

Change of level junctions are available factory vulcanised to meet the requirements for changing level from road deck to footway.

The junctions are fabricated such that the change in level from road to footway takes place behind the kerb line. Leg lengths, the included angles and the male or female end configurations should be specified at the time of order.

### On-site modification

Whilst factory vulcanised change of level junctions should be used as far as possible it may be necessary to modify standard units on-site to accommodate changes of level from road to footway.

This is achieved by cutting and notching the steel bridging system and steel angles and bending the units through 30°. The point of change of level from road to footway taking place behind the kerb line. The void in the kerb line being protected with galvanised steel cover plate.

Details on change of level modifications available from Universal Sealants (UK) Ltd.



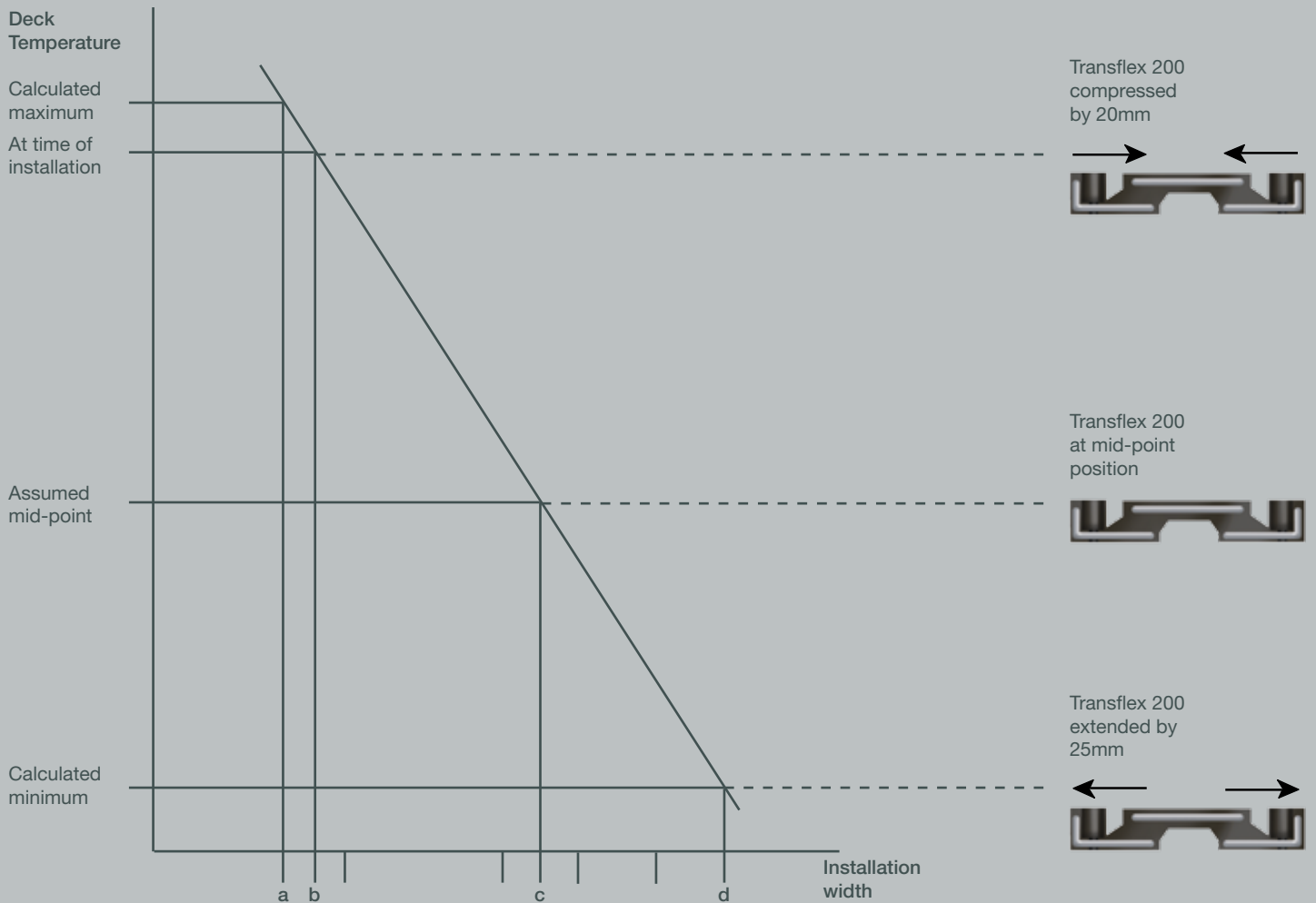

## Installation

### Transflex temperature adjustment guide

It will often be necessary to pre-compress or pre-extend the Transflex joint to pre-set the joint unit to suit the relative position of the structural expansion joint in the bridge deck.

At the time of installation therefore knowing the mean deck temperature range and the movement to be accommodated, the amount of pre-compression or pre-extension can be taken off a graph prepared in the manner of the example illustrated.

#### NB.

1. Example based on model 200 (274mm wide)
2. The example assumes a total design movement accommodation requirement of + and - 25mm from the mid point position.

3. The installation temperature requires that the joint be compressed to 254mm overall width - prior to installation.
4. Hence the new bolt hold centres "C" to be drilled in the structural concrete will be 199mm instead of 219mm.
5. Maximum movement of joint + and - 25mm.
6. Actual movement required + and - 25mm

#### Key:

- a. Maximum compression  $274 - 25 = 249\text{mm}$
- b. Compressed width for installation 254mm
- c. Actual module width 274mm
- d. Maximum extension  $274 + 25 = 299\text{mm}$

### Site installation - for concrete decks

A flat and level monolithic haunch or recess should be formed in the structural deck to accommodate the Transflex joint and the transition strips.

At the design stage care should be taken to locate the reinforcement avoiding the position of the bridge joint anchor studs.

In the interest of achieving a smooth traffic ride over the joint, the wearing course should be machine laid continuously over the structural joint and subsequently removed just prior to installing the bridge joint.

The removal of the surfacing over the joint in the deck is facilitated by the location of the plywood bond breaker of a width just under the combined width of the joint and the transition strips prior to the surfacing being laid. At the time of installation dependent upon mean deck temperature it may be necessary to pre-compress or pre-extend the Transflex joint unit to suit the relative position of the structural expansion joint in the bridge deck.

The installation width of the joint may be determined using graphical means illustrated in the example under the heading "Temperature Adjustment Guide".

Once the Transflex module installation width and the new bolt hole centres have been determined the joint module can be adjusted in width accordingly.



## Installation (continued)

The surfacing may then be sawn and removed to the dimension equivalent to the installation width of the joint plus the two transition strips. The exposed concrete should be scabbled and the final level of the bed adjusted using a polymer modified screed approximately 20mm thick maintaining the recess depth "R" ie 46mm in the case of model 200.

The bridge joint modules centred over the expansion joint in the deck may then be used as templates for the pilot holes thus determining the final position of the bolt holes or by use of a prepared template.

The final bolt holes should be drilled and studs installed using chemical fixing anchors. Each bridge joint unit may then be laid into position over the studs on beads of bedding sealant. The plain clipped washers supplied with each unit are then located, and the assembly bolted down.

Subsequent modules should then be located and fixed in the same way, the sealant first being applied to the tongue and groove edges of each unit prior to jacking into position to ensure a substantially waterproof junction.

The fixing nuts should be tightened to the rate indicated for each model and the polyureide resin transition strips laid level with the wearing surface but finished slightly higher (3mm) than that of the top of the bridge joint module.

Following final torque checks on the fixing nut, the bolt holes should be filled with Transflex Bolt Hole Sealant to protect the stud against corrosion.

### Waterproof Installations

For improved waterproofing it is necessary to incorporate Uniflex Secondary Membrane which should be fixed with epoxy adhesive to the top surface of the levelling screed over the full width of the Transflex Unit prior to the sealant bedding application. The recess depth R should be adjusted by +3mm.

### Further Information

1. USL Transflex Installation Manual  
The detailed Installation Guide sets out the recommended installation procedure for Transflex bridge joints.
2. USL Transflex Product Schedules  
Detailed product schedules for each joint module set out the components available against each Transflex model type.

### Ancillary materials and equipment

Materials:  
Studs and Chemical fixing anchors – See chart under heading "Description for recommended diameter and type"

Uniflex membrane for waterproof applications.

Uniseal 120, one part polysulphide for bedding and sealing each module.

Transflex Bolt Hole Sealant for filling bolt holes.

Transflex Levelling Screed polymer modified mortar for use as a levelling screed or bed.

Britflex polyureide resin for forming transition strips between road wearing surfaces and the module joint.

---

## Installation (continued)

---

### Equipment:

Extension/compression tool for adjusting and pre-setting the module joint to suit temperature/joint gap at time of installation.

Rotary percussion drill; Forced action mixer 'G' Gun; Torque spanner; Jacking equipment.

## Additional Information

There are no health hazards associated with USL Transflex in normal use.

### Ancillary materials

Health and safety data sheets for Uniseal 120, Transflex Bolt Hole Sealant, Transflex Levelling Screed are available separately from USL's Technical Service Department.

### Important Note

Whilst all reasonable care is taken in compiling technical data on the company's products all recommendations or suggestions regarding the use of such products are made without guarantee since the conditions of use are beyond the control of the company. It is the customer's responsibility to satisfy himself that each product is fit for the purpose for which he intends to use it and that the actual conditions of use are suitable.

## Universal Sealants (U.K) Ltd

---

### USL BridgeCare

A division of Universal Sealants (UK) Limited

Offering the complete service for bridge deck protection.

- Expansion joints
- Spray membranes
- Concrete repairs

[www.usluk.com](http://www.usluk.com)

### USL StructureCare

A division of Universal Sealants (UK) Limited

Supply and installation of expansion joints, protective coatings, concrete repairs and joint sealants to car parks, elevated structures and the construction industry.

[www.structurecare.com](http://www.structurecare.com)

### Nufins

A division of Universal Sealants (UK) Limited

Manufacturers and suppliers of formulated products for civil engineering, construction, repair and refurbishment.

[www.nufins.com](http://www.nufins.com)

### Visul Systems

A division of Universal Sealants (UK) Limited

A manufacturer, supplier and installer of surface mounted tactile paving.

[www.visulsystems.com](http://www.visulsystems.com)



[www.usluk.com](http://www.usluk.com)

**USL BridgeCare**

Kingston House  
3 Walton Road  
Pattinson North  
Washington  
Tyne & Wear  
NE38 8QA  
United Kingdom

t: +44(0)191 416 1530  
f: +44(0)191 415 4377  
e: [info@usluk.com](mailto:info@usluk.com)

**Pitchmastic Pmb (International)**

P.O Box 54220  
Dubai, UAE

t: +971 4 437 6412  
f: +971 4 368 6819  
e: [dubai@pitchmasticpmb.co.uk](mailto:dubai@pitchmasticpmb.co.uk)  
w: [www.pitchmasticpmb.com](http://www.pitchmasticpmb.com)

**Asia Office**

USL Asia Pacific PTE  
50 Tuas Crescent  
Singapore  
638730

t: +65(0) 68636363  
f: +65(0) 68619566  
e: [info@usluk.com](mailto:info@usluk.com)

